

PRODUCT
CATALOG

2024

With more than 10 years of experience in printing and making, Specialized in producing and designing customized packaging products. With the advantage of cutting-edge manufacturing technology and experienced design team, we provide our customers with one stop top-quality packaging solutions. So as to benefit their brands and business grow.

Taki Industry And Trade Co.,Ltd

漳州达壹工贸有限公司

Your Products Packaging Manager

- SGS Group Verified the factory.
- 10+ years of experience in the making and print field.
- Export Packaging Products To Over 20+ Countries.

Company Profile

01. Corrugated Paper Box

- 01-1.** Packaging Box For Shipping
- 01-2.** More Shape Of Packaging Box

02. Products Packaging Box

- 02-1.** Vial Packagaing Box And Label
- 02-2.** Hair/Wig Packagaing Box
- 02-3.** Candle Packaging Box
- 02-4.** Soap Packaging Box
- 02-5.** Cosmetic Packaging Box

03. Boutique Gift box

- 03-1.** Gift Fold Box

04. Holiday/Party Decoration

- 04-1.** Paper Ornaments

05. Packaging Bag

- 05-1.** Kraft paper bag
- 05-2.** Zipper bag
- 05-3.** Brand Paper Bag
- 05-4.** Hologram bag

06. Shipping Packaging

- 06-1.** Shipping Mailer Bags
- 06-2.** Shipping Bubble Bags
- 06-3.** Shipping Tape

07. Recycle Product Protective Packaging

- 07-1.** Wrapping paper
- 07-2.** Shredded Paper
- 07-3.** Cushion Packaging Material

08. Packaging For Store

- 08-1.** Paper Cup
- 08-2.** Cup Sleeve

09. More Related Products

- 09-1.** Cloth Label
- 09-2.** Cloth Hang Tag
- 09-3.** Paper Envelope
- 09-4.** Paper Card (Greeting Card, Introduction Card and so on)
- 09-5.** Box / Products / Cup Sleeve
- 09-6.** Sticker
- 09-7.** Custom Ribbon

Company Profile

Taki Industry And Trade Co., Ltd, Is A Manufacturer And Exporter Providing All Kinds Of Products Packaging.

With more than 10 years of experience in printing and making, Specialized in producing and designing customized packaging products. With the advantage of cutting-edge manufacturing technology and experienced design team, we provide our customers with one stop top-quality packaging solutions. So as to benefit their brands and business grow.

Since 2016 PackTaki has built a reputation in worldwide as a successful factory by manufacturing the highest quality packaging products.

Our customers don' t have to worry about transportation, A complete and efficient to-door service shipment management is offered by PackTaki, with delivery available anywhere in the world at competitive prices. Shipping options by air, sea, or train can be chosen by clients depending on their time and budget requirements. Our location in proximity to Xiamen Seaport and Xiamen international airport, which is less than 60 kilometers away, allows for added convenience in the delivery process.

With the competitive advantage of products and considerate after-sales services, PackTaki has built long-term partner relationships with more than 100+ brands, And Factory gets verified by SGS and Intertek.

As a reliable supplier in the global market, PackTaki aims at providing one-stop top-quality packaging solutions which strictly comply with Eco-Friendly standards to protect clients' product safety, so as to help all of the customers to find valuable packaging.

We will be committed to continuing to innovate and exceed expectations in the packaging industry, to help your brand gain the adoration and recognition it deserves worldwide.

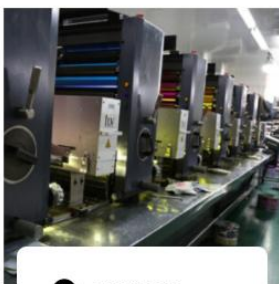

➔ PRINTING



➔ Colors Checked

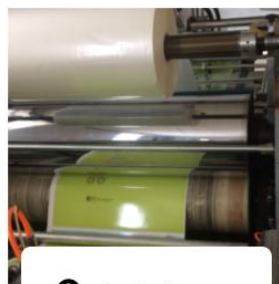

➔ Lamination

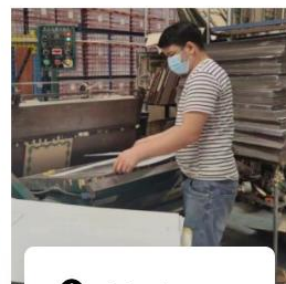

➔ Artwork

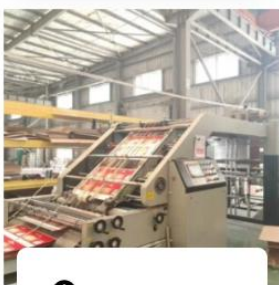

➔ Glue with another paper

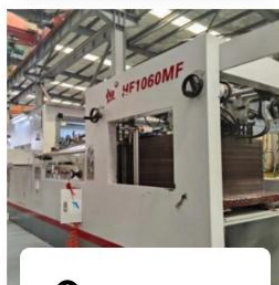

➔ Die cutting

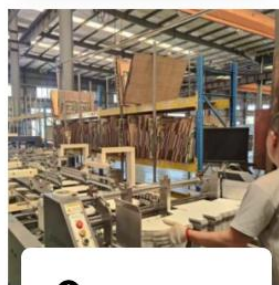

➔ Folded

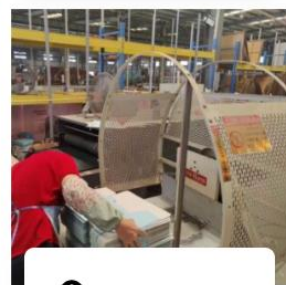

➔ Packaging

01. Corrugated Paper Box

01-1. Packaging Box For Shipping



C FLUTE

0.141" height, 37 flutes per linear foot
TU = 1.42

B FLUTE

0.094" height, 45 flutes per linear foot
TU = 1.31

E FLUTE

0.047" height, 90 flutes per linear foot
TU = 1.25

F FLUTE

0.030" height, 128 flutes per linear foot
TU = 1.22

N FLUTE

0.0196" height, 168 flutes per linear foot
TU = 1.17

Box: sturdy, load-bearing ,enough strong for shipping





Mailer Box Style



T-01



T-02



T-03



T-04



T-05



T-06



T-07



T-08



T-09



T-10



T-11



T-12



T-13



T-14



T-15



T-16

01.Corrugated Paper Box

01-1. Packaging Box For Shipping

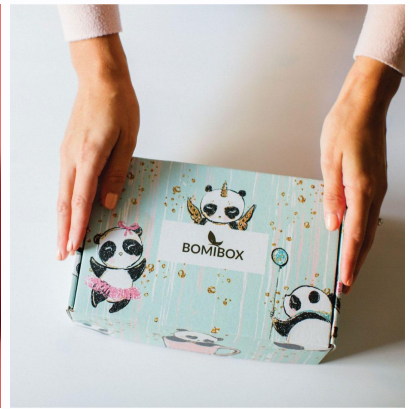

Popular Box Size	Customized, Stock sizes available. Please check "More Sizes & More Choices" for more details. Common sizes: 6 x 6 x 2 in 7 x 5 x 1 1/2 in 9 x 6 x 3 in 9 x 7 x 4 in 10 x 8 x 2 in 10 x 8 x 4 in 11 x 8 x 2 in 12 x 9 x 3 in 12 x 9 x 4 in 12 x 12 x 2 in
Thickness	0.8–3Mm, It Depends On The Ratio Of The Material
Print Options	1. Only External Of Shipping Box 2. External And Internal Printing Of Mailing Box
Colors Options	Single Color Or Cmyk Colorful Print On Mailer Box
Finish	Glossy/Matt Lamination Recyclable ink, Gold/silver Foil Stamping Spot UV, Embossed, etc.
Carft	Foid stamping, color can be gold, silver, red, purple and so on, UV sport, Embossed, Debossed and so on

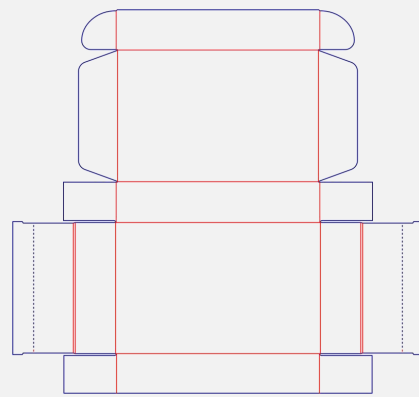

 Our company supports structure customization. If your product is special or needs to be fixed in the box, we can develop a suitable lining according to your product to prevent the product from moving in the box during transportation or use. The size is also not fixed and can be tailored to your needs, **MOQ is 500pcs** for custom-made products

01. Corrugated Paper Box

01-2. More Shape Of Packaging Box



01. Corrugated Paper Box

01-2. More Shape Of Packaging Box

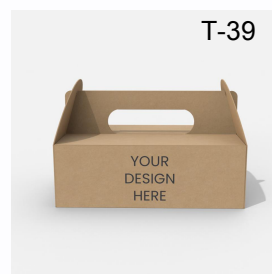
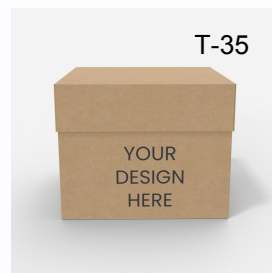
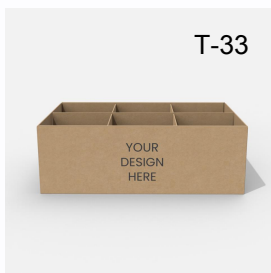
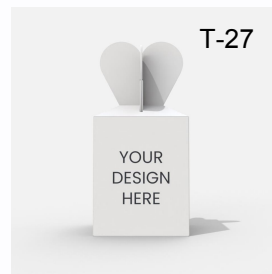
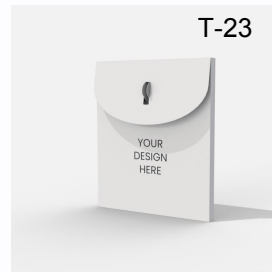
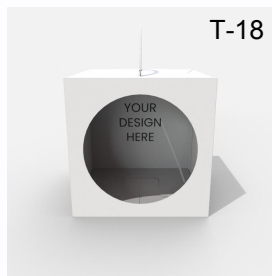
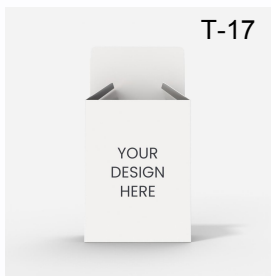

02. Products Packaging Box

02-1. Vial Packaging Box And Label



Popular Box Size	25*25*60mm for 10ml box 30x80mm for 10ml bottle label
Thickness	250gsm,300gsm,350gsm white card paper based on request
Print Options	CMYK or Pantone colors
Finish	Glossy/Matt Lamination Recyclable ink,Gold/silver Foil Stamping Spot UV, Embossed, etc.
Carft	Foild stamping,color can be gold,silver,red, purple and so on, UV sport,Embossed,Debossed and so on



Please Send us your details to Custom-Made

1. Size
2. Design Moq is 100pcs
3. Carft/Artwork
4. Quantities
- 5.Address for shipping checked

02. Products Packaging Box

02-2. Hair/Wig Packagaing Box



Popular Box Size	11x9x2.4inches 10x6x2inches
Thickness	250gsm,300gsm,350gsm white card paper based on request
Print Options	CMYK or Pantone colors
Finish	Glossy/Matt Lamination Recyclable ink,Gold/silver Foil Stamping Spot UV, Embossed, etc.
Carft	Foild stamping,color can be gold,silver,red, purple and so on, UV sport,Embossed,Debossed and so on



Please Send us your details to Custom-Made

1. Size
2. Design Moq is 100pcs
3. Carft/Artwork
4. Quantities
- 5.Address for shipping checked

02. Products Packaging Box

02-3. Candle Packaging Box **02-4. Soap Packaging Box** **02-5. Cosmetic Packaging Box**



Candle Box

85x85x100mm



Soap Paper Box Packaging with Custom Design

90*65*25mm

95*85*30



Essential oil bottle box, cosmetic bottle box

28*28*70mm for 10ML

32*32*77mm for 15ml

31*31*83mm for 20ml

36*36*90mm for 30ml

40*40*102mm for 50ml

48*48*124mm for 100ml



Lipstick Box, Lip Gloss Paper Packaging with Custom Design

78x22x22mm

88x27x27mm

92x32x20mm

120x20x20

Custom-Made
Size, design, Moq is
100 pcs

03. Boutique Gift Rigid Boxes

03-1. Gift Fold Box



Popular Box Size	Customized, Stock sizes available. Please check "More Sizes & More Choices" for more details. Common sizes: 23x15x10cm 31x20x10cm 35x23x10cm 40x30x9
Materials	1. Art paper (128g, 157g, 200g, 210g, 230g, 250g, 300g) 2. Ivory board paper (210g, 230g, 250g, 300g) 3. Kraft paper (brown/white kraft paper) (200gsm, 250gsm, 300gsm, 350gsm, 400gsm, 450gsm) 4. Grey Card Paper: 600–1000gsm, 1200gsm, 1400gsm, 1800gsm or more.
Print Options	Offset printing, silk screen printing, and so on, as customer's requirement
Finish	Glossy/Matt Lamination Or recyclable ink, Gold/silver Foil Stamping, Spot UV, Embossed, etc.
Carft	Foild stamping, color can be gold, silver, red, purple and so on, UV sport, Embossed, Debossed and so on
Accessorv	Ribbon. EVA. PET VAC. Paper trav or Sponae



Before Folded



After Folded

Custom-made design, size, moq is 500 pcs



No. CS-12

15cm / 20cm / 30cm



No. CS-13

18.5*18.5*25cm



No. CS-14

15*15*20.5cm



No. CS-15

15cm / 20cm / 25cm
30cm / 35cm / 40cm
50cm



No. CS-16

13.5*13.5*40cm



No. CS-17

9.3*9.3*25cm



No. CS-18

16.5*16.5*25cm
18.5*18.5*30cm



No. PD-2 Old Design

7cm / 10cm / 15cm / 20cm
25cm / 35cm / 40cm



No. PD-3

7cm / 12cm / 15cm / 20cm



No. PD-4 New Design

10cm / 12cm / 15cm / 20cm / 25cm



No. PD-5

10cm / 15cm



No. PD-6

10cm / 15cm / 20cm / 30cm



No. PD-7

6cm / 10cm



Accept OEM/ODM



250 gsm paper , gold dust, with velcro

Size : 60cm / 90cm / 120cm / 150cm / 180cm / 240cm

04. Holiday/Party Decoration

04-1. Paper Ornaments



No. PD-8

10cm / 15cm / 20cm
30cm / 35cm



No. PD-9

10cm / 15cm



No. PD-10

12cm / 15cm
20cm / 25cm



No. PD-11

10cm



No. PD-12

12cm / 40cm



No. PD-13

10cm / 15cm / 20cm / 25cm
30cm / 35cm / 40cm



No. PD-14

8*6.5cm



No. PD-15

10*11cm
13.5*12.7cm



No. ES-14 (120+180gsm)

90cm / 110cm



No. ES-15 (180gsm)

60cm / 80cm



No. ES-16

18cm / 60cm / 100cm



No. ES-17

30cm / 40cm
50cm



No. ES-18

20cm / 30cm
40cm



No. ES-19

20cm / 30cm
40cm



No. ES-20

30cm / 40cm / 50cm
80cm / 100cm



No. ES-21

20cm / 30cm
40cm

Can Be Custom-made your Shape you need.
Contact us to get more model for reference.
Moq is Standard size in stock:1pcs
customized size:100pcs

05. Packaging Bag

05-1. Kraft paper bag



Popular Bag Size (L X W X H)	Customized, Stock sizes available. Please check "More Sizes & More Choices" for more details. Common sizes: 21*11*27cm; 28*15*28cm; 20.5*14*27.5cm; 28*22*28cm; 23*23*23cm; 20*11*22cm; etc.
Materials	White Kraft paper, Or Brown Kraft paper 80gsm, 90gsm, 100gsm, 110gsm, 120gsm, 150gsm, 180gsm or Customized
Inside Finishing	Support BOPP sealable (anti oil & water liquid) Full or Partial PP for choice
Print Options	1. Only External Of Shipping Box 2. External And Internal Printing Of Mailing Box
Colors Options	Single Color Or Cmyk Colorful Print On Mailer Box
Finish	Glossy/Matt Lamination Recyclable ink, Gold/silver Foil Stamping Spot UV, Embossed, etc.
Carft	Foild stamping, color can be gold, silver, red, purple and so on, UV sport, Embossed, Debossed and so on

Made Bags Based on your request about logo colors, Size, and quantities request. Moq is Standard size: 100 pcs
customized size: 1000 pcs

Reference More At Next Image For Size List

05. Packaging Bag

05-1. Kraft paper bag

#1



21x11x27cm

#2



28x15x28cm

#3



20.5x14x27.5cm

#4



28x22x28cm

#5



23x23x23cm

#8



20x11x22cm

#9



25x14x24cm

#13



23x18x25cm

#14



26x20x27.5cm

#15



15x8x21cm

#16



13x13x20cm

#17



16x16x20cm

#18



17.5x17.5x25cm

#19



20x20x24cm

#20



25x25x25cm

#21



28x28x28cm

#22



31x31x22cm

#23



42X14X31cm

#24



25X11X32cm

#25



42X14X41cm



05. Packaging Bag

05-2. Zipper bag



Min Size	10x15cm 14x20cm	Small items, cosmetics, hair accessories
Small Size	17x25cm 20x25cm 20x28cm 20x30cm	Toiletries, towel and underwear
Middle Size	24x35cm 25x30cm 25x35cm 28x36cm 28x40cm	T-shirt, jeans, and scarf
Big Size	30x40cm 35x45cm	Hoodies, sweaters and blankets Jacket, windbreaker, sportswear
Bigger Size	40x50cm	Jacket, windbreaker, sportswear suits and flannel Pajamas
Biggest Size	45x50cm 40x60cm	Thick clothes and pillows
MOQ	Standard size: 100pcs customized size: 1000pcs	



Transparent

Matte/Frosted

05. Packaging Bag

05-2. Zipper bag



Hologram Bags Regular Size	10.5x15cm
White Bags Popular Size	6x10cm;7x10cm;7x14cm;7x20cm;7.5x12cm 8x13cm;8x14cm;8.5x11cm;8.5x16cm; 9x12cm;9x14cm;9x16cm 10x12cm;10x18cm;10.5x15cm; 11x16cm;11x18cm; 12x15cm;12x20cm;12x23cm; 13x17cm;13x21cm;13x24cm; 14x20cm;14x23cm;14x27cm; 15x21cm;16x20cm;16x24cm; 18x20cm;18x26cm; 20x27cm;20x30cm;21x26cm;22x30cm; 23x33cm;25x35cm;27x37cm;30x40cm; 32x45cm;35x45cm
Black Bags Popular Size	6x8cm;7x10cm;8x12cm; 9x13cm;9x16cm;10x15cm; 10x18cm;12x20cm;14x20cm; 15x22cm;16x24cm;18x26cm;20x30cm
MOQ	Standard size:100pcs customized size:based on design to check moq
Materails:	aluminizing bag/PET/ CPP, 8um/12um/16um...
Used	All kinds of electronic products, digital accessories, video, stationery, nut snacks, cosmetics, clothing and so on

05. Packaging Bag

05-3. Brand Paper Bag



Popular size (LXWXH)	Small	Medium	Large	Extra large
	110x50x90mm	190x90x220mm	300x150x415mm	435x130x540mm
	120x60x195mm	200x100x275mm	310x150x415mm	350x150x450mm
	160x80x200mm	205x100x255mm	320x140x400mm	440x160x480mm
	180x80x250mm	250x110x300mm	305x150x405mm	460x150x490mm
	200x80x250mm	260x120x400mm	350x140x350mm	450x150x550mm
Materials	1. Art paper (128g,157g,200g,210g,230g,250g,300g) 2. Ivory board paper(210g,230g,250g,300g) 3. Kraft paper(brown/white kraft paper) (100gsm,120gsm,150gsm,200gsm,250gsm,300gsm)			
Print Options	Offset printing, silk screen printing, and so on, as customer' s requirement			
Finish	Glossy/Matt Lamination Or recyclable ink,Gold/silver Foil Stamping,Spot UV, Embossed, etc.			
Carft	Foild stamping,color can be gold,silver,red, purple and so on, UV sport,Embossed,Debossed and so on			
MOQ	Standard size:100pcs customized size:1000pcs			



05. Packaging Bag

05-4. Hologram bag



Popular size with horizontal version	20x18x10cm 28x25x15cm 34x30x10cm/8cm 35x28x9cm 40x10x30cm
Popular Size with vertical version	18x20x10cm 25x28x15cm 30x34x10cm
Regular materials	12um
Handle style	Ribbon with logo print or without logo print, leather handle and so on
MOQ	Standard size:100pcs customized size:1000pcs

06. Shipping Packaging

06-1. Shipping Mailer Bags



Popular Color	White,Black,Grey,Purple,blue,yellow,green,Pink,Rose pink and so on.
Popular Size	17x30cm; 20x30cm; 25x35cm; 28x42cm; 30x42cm; 32x45cm; 35x45cm; 38x52cm; 40x55cm; 45x60cm;
Print Color	Single or different colors of logo,based on request
MOQ	Standard size:100pcs customized size:1000pcs

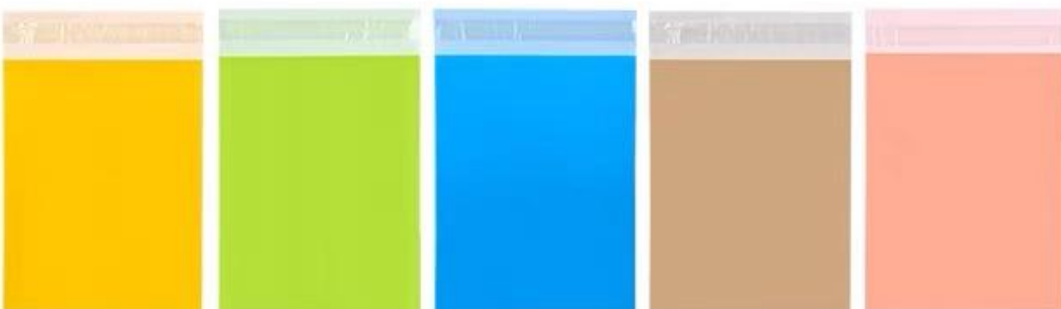

06. Shipping Packaging

06-2. Shipping Bubble Bags



Popular Color	White,Black,Grey,Purple,blue,yellow,green,Pink,Rose pink and so on.
Popular Size	11X13+4 13X18+4 15X20+4 18X20+4 18X23+4 20X25+4 25X30+4 28X37+4 28X37+6 33X40+6 38X46+6
Print Color	Single or different colors of logo,based on request
MOQ	Standard size:100pcs customized size:1000pcs

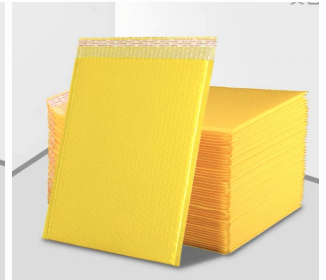
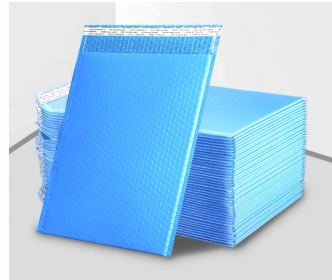



Popular Color

<p>2 潘通色103c</p> <p>普金 C28 M31 Y100 K0</p>	<p>3 潘通色142c</p> <p>米黄 C0 M30 Y100 K0</p>	<p>4 潘通色143c</p> <p>原黄 C0 M0 Y100 K0</p>	<p>5 潘通色151c</p> <p>桔黄 C0 M55 Y100 K0</p>	<p>6 潘通色1505c</p> <p>桔红 C0 M80 Y100 K</p>
<p>9 潘通色2395c</p> <p>玫红 C0 M100 Y0 K0 拓展176</p>	<p>11 潘通色1797C</p> <p>大红 C0 M100 Y100 K0 拓展152</p>	<p>12 潘通色1797C</p> <p>暗红 C0 M100 Y100 K25 拓展153</p>	<p>13 潘通色211C</p> <p>粉红 C0 M65 Y0 K0</p>	<p>14 潘通色红紫C</p> <p>紫色 C40 M80 Y0 K0</p>
<p>7 潘通色7583c</p> <p>浅咖啡 C30 M75 Y100 K0</p>	<p>39 潘通色7597c</p> <p>酒红 C27 M90 Y100 K0</p>	<p>33 潘通色7595c</p> <p>深咖 C45 M70 Y90 K40</p>	<p>34 潘通色7595c</p> <p>黑色 C0 M0 Y0 K100</p>	<p>24 潘通色7595c</p> <p>深蓝 C100 M100 Y0 K</p>
<p>19 潘通色360c</p> <p>黄绿 C60 M0 Y100 K0</p>	<p>17 潘通色360c</p> <p>(专) 草绿 C100 M0 Y100 K0</p>	<p>18 潘通色562c</p> <p>墨绿 C100 M0 Y60 K50</p>	<p>22 潘通色562c</p> <p>兰绿 C75 M0 Y30 K0</p>	<p>21 潘通色562c</p> <p>天蓝 C20 M100 Y0 K0</p>
<p>37 潘通色562c</p> <p>纯白 C0 M0 Y0 K0</p>	<p>30 潘通色562c</p> <p>银灰色 C0 M0 Y0 K45 调色黑1KG/白6KG</p>	<p>38 潘通色562c</p> <p>深灰色 C0 M0 Y0 K70 调色黑1KG/白3KG</p>	<p>35 潘通色562c</p> <p>反光红金色 需要加收费用</p>	<p>36 潘通色562c</p> <p>反光银色</p>

Regular Size	4.4cm,4.8cm,5.5cm,6cm x 100 meters one rolls
Print Color	Logo single color or colorful,based on your request
MOQ	10rolls for stock, custom-made colorful design/background moq is 200rolls

07. Recycle Product Protective Packaging

07-1. Wrapping paper



Popular Size	10x15inches(25.4*38cm)15*20inches(38*50.8cm)20*25 inches(50*63.5cm)20*30inches(50*76cm)
Thickness	17g,28g,30g,60g,80g,95g
Print Options	Basic ink or eco-friendly soy ink with 1-2 colors print
Packaging	Clothes, shoes, all kinds of cosmetics, all kinds of skin care products,handicrafts, accessories, gifts, etc.

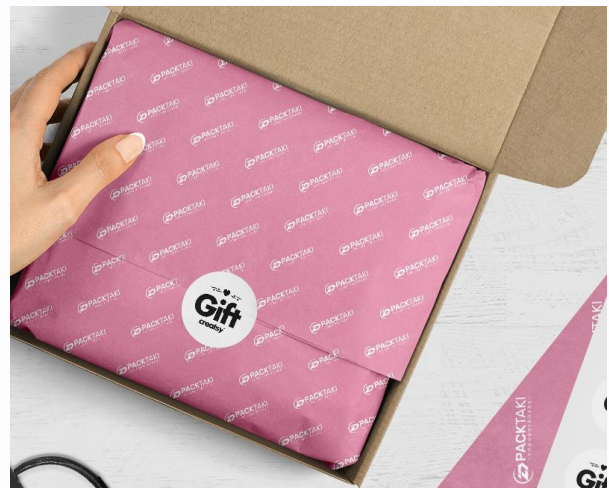
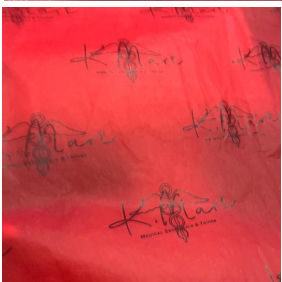
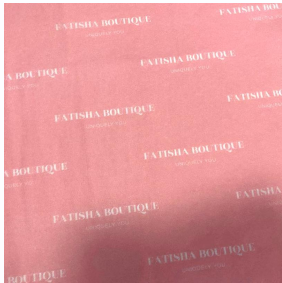

PANTONE 1895 C
C:0 M:30 Y:6 K:0



PANTONE 196 C
C:0 M:27 Y:6 K:0



PANTONE 203 C
C:0 M:34 Y:0 K:0



PANTONE 210 C
C:0 M:43 Y:6 K:0



PANTONE 1905 C
C:0 M:43 Y:6 K:0



PANTONE 197 C
C:0 M:47 Y:11 K:0



PANTONE 204 C
C:0 M:60 Y:0 K:0



PANTONE 211 C
C:0 M:56 Y:6 K:0

07. Recycle Product Protective Packaging

07-1. Wrapping paper

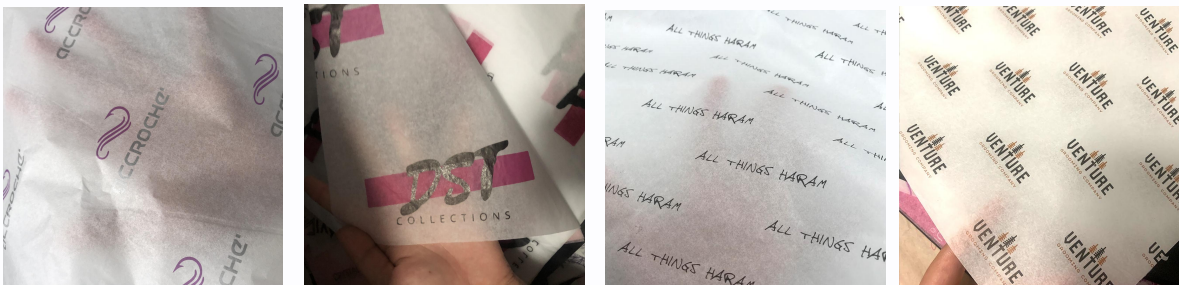

MF 1103		MF 4109		MF 2304		MF 6301	
MF 1201		MF 4301		MF 3101		MF 7102	
MF 1301		MF 5103		MF 3201		MF 7305	
MF 1308		MF 5201		MF 3304		MF 7503	
MF 1403		MF 6102		MF 3401		MF 8403	
MF 2101		MF 6104		MF 4102		MF 7403	
MF 2201		MF 6202					

07. Recycle Product Protective Packaging

07-2. Shredded Paper



MOQ 100PCS
SINGLE COLOR



07. Recycle Product Protective Packaging

07-2. Shredded Paper



38# 深棕色



39# 浅灰色



40# 蒂芙尼蓝



47# 深绿色



48# 深酒红



49# 深灰色



41# 原木色



42# 浅香槟黄



43# 深咖色



50# 果绿色



51# 藏蓝色



52# 蓝灰色



44# 紫色



45# 紫罗兰



46# 圣诞绿



53# 藏青色



54# 杏白色



55# 驼色



57# 咖红



58# 砖红



59# 卡其色



60# 暗桔色



61# 金色



07. Recycle Product Protective Packaging

7-3. Cushion Packaging Material



Popular Size

28cmx10M
48cmx10M
47cmx10M
66cmx10M
28cmx50M
45cmx50M
48cmx50M
66cmx50M

Style

With torn line, can be tearing, or without torn line.

Color

White, Brown, Black, Red, Pink, Yellow, Blue

Size

30cmx20M/30M/50M
38cmx20/40M



08-1. Paper Cup



Popular Color	Kraft Cup/White Cup with design print																
Popular Size	<table border="1" style="margin-top: 10px;"> <thead> <tr> <th>Size</th> <th>8OZ</th> <th>12OZ</th> <th>14OZ</th> <th>16OZ</th> <th>22OZ</th> </tr> </thead> <tbody> <tr> <td>Volume</td> <td>280ml</td> <td>330ml</td> <td>400ml</td> <td>500ml</td> <td>700ml</td> </tr> </tbody> </table>					Size	8OZ	12OZ	14OZ	16OZ	22OZ	Volume	280ml	330ml	400ml	500ml	700ml
Size	8OZ	12OZ	14OZ	16OZ	22OZ												
Volume	280ml	330ml	400ml	500ml	700ml												
Print Color	Single or colorful print, based on your design request																
MOQ	Standard size: 1000pcs																

 You May Buy Together



Lid of paper cup
&
Straws for coffee Cup
&
Recycle Cup Holder

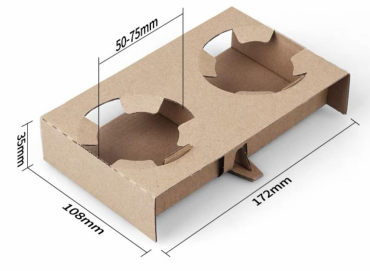
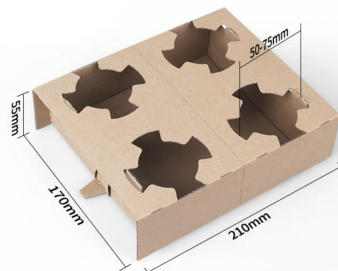
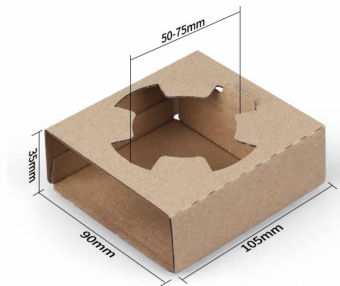
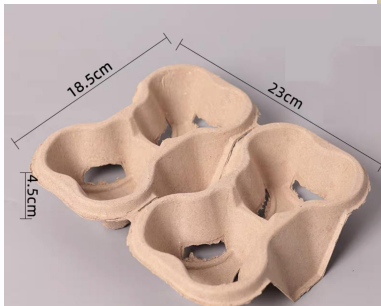
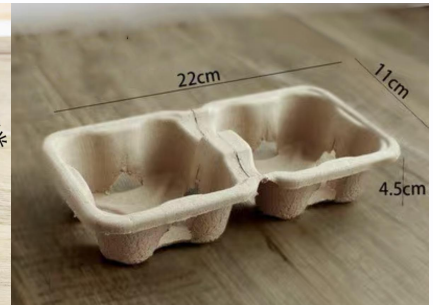
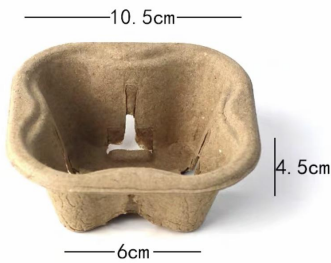

09-1. Cloth Label: Woven label: Main label, Size label, Care label, Name label, Wash label

Background	Heat seal backing / plastic backing / no backing / adhesive backing / hook and loop backing / pin backing
Fold Style	End fold, Center fold, straight cut, Laser cut, Loop fold and so on
Materials	Polyester, Stain, Damask, Cotton
Used	Widely used for garment, shoes, bags, hats and textiles, gifts, crafts, advertisement, promotion, collection, souvenir etc.
MOQ	100pcs



Custom sizes available

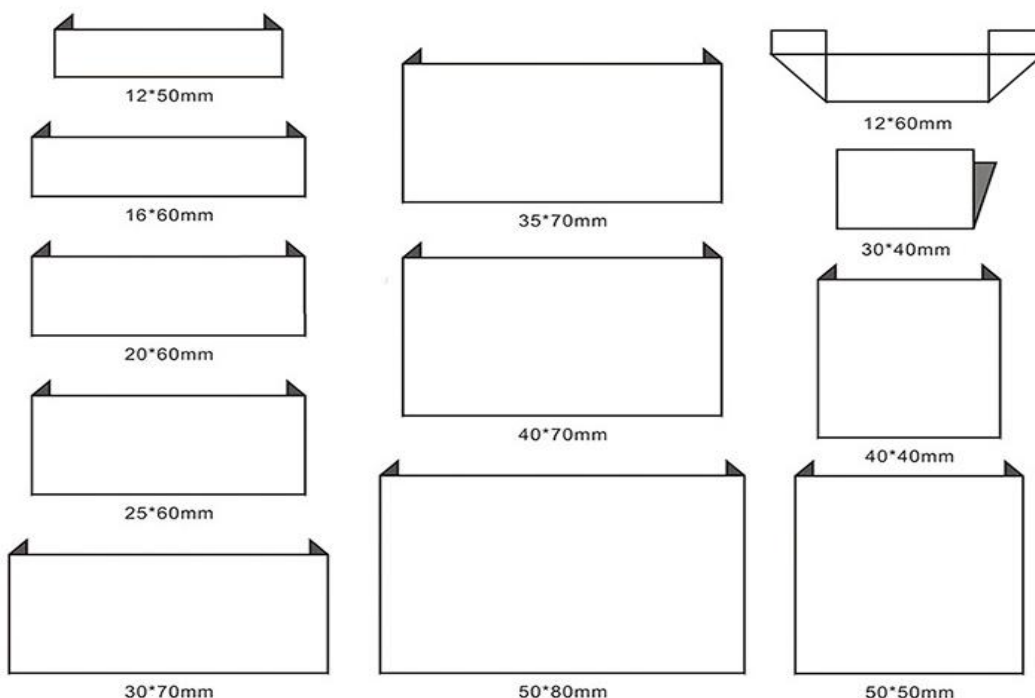

 09-1. Cloth Label



Leather patch



Rubber Patch



Washing Label



Contact us to get more model for reference.
Moq is 500pcs With Your design

09-2. Cloth Hang Tag

Thickness	300gsm,500gsm,700gsm,1000gsm,1500gsm
Craft	CMYK Printing / Hot Stamping / Silver Foil Stamping / Embossing & Debossing / Spot UV /
Materials	Coated Paper, Offset Paper, Kraft Paper, Duplex Paper, Black Paperboard, Paperboard, Ivory board, PVC as well as Special Paper ,seed paper, etc
Accessories 1	eyelets: iron eyelets, copper eyelets, plastic eyelets, paper eyelets
Accessories 2	string: cotton, waxed, ribbon, plastic hang tags, bullet tags, nylon string, hemp rope,etc
MOQ	1000pcs



09-3. Paper Envelope

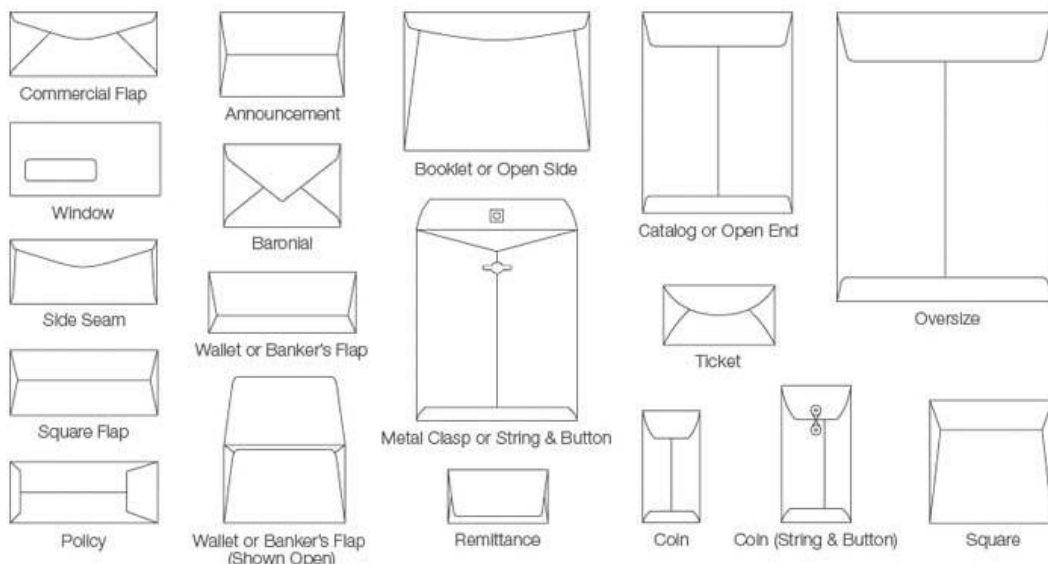

 09-3. Paper Envelope

	Size in mm	Size in inches		Size in mm	Size in inches
A1	594 x 841	23 ³ / ₄ x 33 ¹ / ₈	C3	475 x 324	18 x 12 ³ / ₄
A2	420 x 594	16 ¹ / ₂ x 23 ³ / ₈	C4	324 x 229	12 ³ / ₄ x 9
A3	297 x 420	11 ³ / ₄ x 16 ¹ / ₂	C5	229 x 162	9 x 6 ³ / ₈
A4	210 x 297	8 ¹ / ₄ x 11 ³ / ₄	C6	114 x 162	4 ¹ / ₂ x 6 ³ / ₈
A5	148 x 210	8 ⁷ / ₈ x 8 ¹ / ₄	DL	110 x 220	4 ¹ / ₄ x 8 ⁵ / ₈

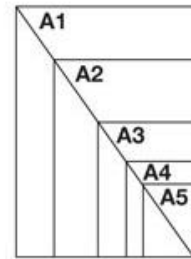

Flat



C3



Flat



C4



C4 Wallet
229 x 324mm
9 x 12³/₄



Folded once

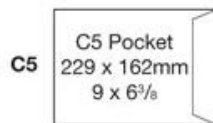

C5

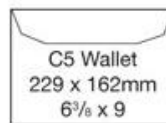

C5 Wallet
229 x 162mm
6³/₈ x 9



A5

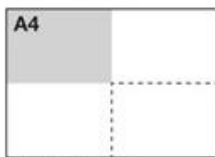

Folded twice

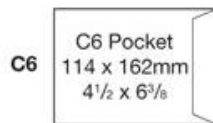

C6



A5

Folded once

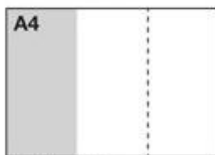

Folded twice

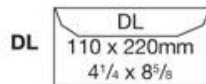

DL

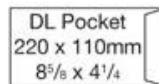

DL Pocket
220 x 110mm
8⁵/₈ x 4¹/₄



A5

Folded once

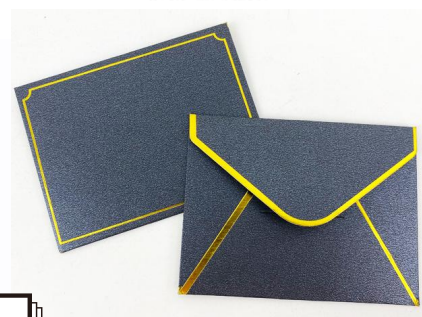

MOQ is 300pcs with custom-made your own design, color need materials can be chosen

09-4. Paper Card (Greeting Card, Introduction Card and so on)

Standard invitation sizes

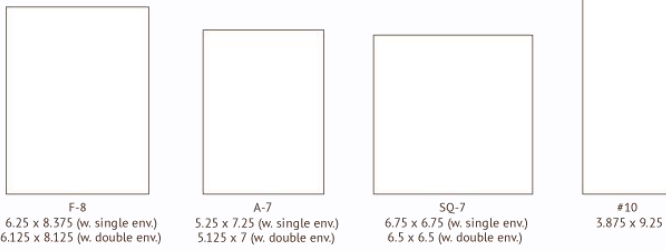

Other available sizes

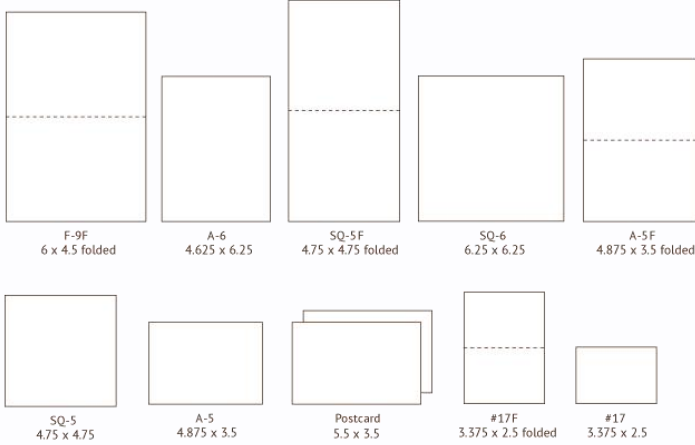

09-5. Box / Cup/Products Sleeve



 09-6. Sticker



Materials	Adhesive laster material, holographic material, glitter material, diamond glossy material, Vinyl ,etc
Size	Round 3cm,4cm,5cm and custom-made you need
MOQ	100pcs

09-7. Custom Ribbon With Logo



09-8. Custom Satin Bags With Logo



09-8. Custom Velvet bag With Logo



09-9. Custom cotton bag With Logo



Thank you for reading!!



Dear Customer,

Our product is 100% customized as per your requirement and design.

Please send your print idea, size, quantities of products, and your address, Then we can calculate the accurate prices for you reference.

If you are not sure, pls contact us, we will provide some suggestion.

Thank you for your kind understanding!

Regards

PackTaki



Sales Manager | Nancy



+ 86 157 1504 4920 (what ~~app~~ app)



info@dayipackage.cn



www.cnpaperboxes.com/www.packtaki.com